

High-Performance Door

ASSA ABLOY RR300 Retail

ASSA ABLOY
Entrance Systems

Experience a safer
and more open world



ASSA ABLOY RR300 Retail

- Sight-protection between sales – and storage area
- Avoids access of unauthorized persons
- Suitable for emergency exit applications
(Approval of local building supervision required)
- Crash-resistant & safe

DOOR MATERIAL/CONSTRUCTION

The guide rails and the top roll are made of aluminium.
The construction is self-supporting.

GUIDE RAILS

The guide rails designed in two parts
(Main rail + cover rail) allow easy assembly
and easy access for maintenance.

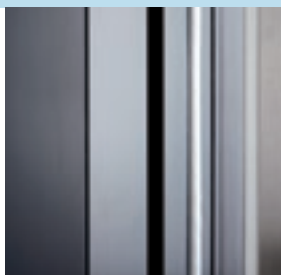

DOOR CURTAIN

By default, a coloured vinyl curtain
is available, which may be supplied
with clear view stripes or a window on
request.

Option:
Optional the door curtain can be printed
individually.



AUTOMATIC EMERGENCY OPENING

A balancing weight located in the side
guide rails allows the full emergency
opening in the event of a power cut. This
makes it possible to approve the door
for emergency exits and escape routes.



FLOOR POLLERS

The 156 mm high floor pollers made of
steel protect the guide rails effectively
against damages by fork lifts.

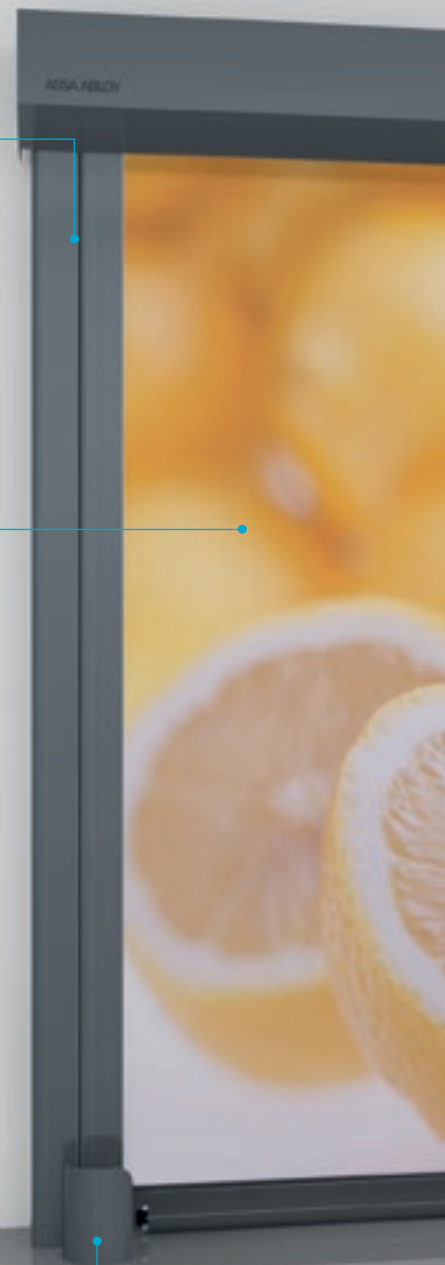



MOTOR AND BARREL COVER

In standard all doors have a RAL coloured motor and barrel cover.



MOTOR POSITION

The doors are available with motorside left or right.

FREQUENCY CONVERTER DOOR CONTROL

The comfortable frequency converter door control DCC 20 with integrated control unit combines high flexibility, quick setup and easy usability.



BREAK AWAY SYSTEM

After a collision, the ASSA ABLOY RR300 Retail door curtain resets itself automatically into the guide rails during the next cycle.

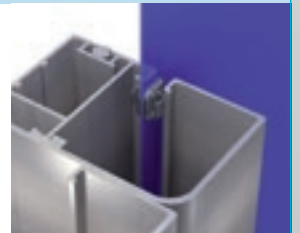

SAFETY LIGHT GRID

The ASSA ABLOY RR300 Retail contains a light curtain integrated in the side guides as a standard safety device. This means additional higher safety and better working conditions for operating staff.

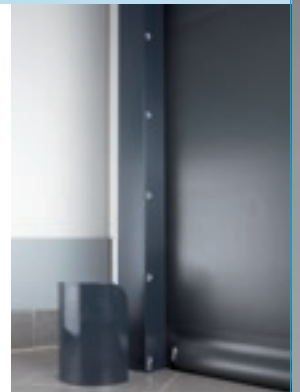

High-Performance Door ASSA ABLOY RR300 Retail

The ASSA ABLOY RR300 Retail door is adapted for applications in supermarkets and warehouses.

In these segments, high-performance doors are mainly used for separating the warehouse and the sales area.

Indoors, the doors are used for screening and to provide protection from theft by preventing unauthorised access. Work processes are optimized thanks to the fast opening speed. The door is easy to use and personnel can operate the door after just a short instruction.

The high safety standards on the door prevent customers or personnel from being injured in the event of unforeseen collisions. In the event of a power failure, the door is equipped with an automatic self-opening function. The door curtain can be printed with individual motifs or the company logo.

The advantages of the ASSA ABLOY RR300 Retail

- Accelerated logistics through a high opening speed
- The flour pollers and the break-away-system minimizes service costs
- A high degree of safety through the flexible bottom profile combined with the safety light barrier
- Automatic opening in the event of a power cut

Technical Details

- Self-supporting door construction
- Side frames from two-piece aluminium profiles coloured (According to the selection list)
- Door curtain made from coloured PVC fabric
- Motor and barrel cover coloured in RAL
- Automatic self-opening with counterweight
- Door control with a frequency converter
- Integrated light grid
- Steel plate bollards protect the side sections from ramming damage and are painted in same colour as the side frames

Options and Accessories

- Colours for the door curtain and door at the request of the client
- Door curtain with horizontal window
- Optional the door curtain can be printed individually
- Prepared for the connection of all common impulse activators and transponder systems
- Europe-wide delivery and installation possible
- Short delivery times
- Wind stiffening
- Curtain-monitoring for protection against backflow and overhang
- Main switch 4-pole (power disconnection)
- Emergency-off switch (Power-off of motor and brake)

Technical data

Application	Interior door
Door dimensions (mm) DW x DH min. DW x DH max.	750 x 1600 2500 x 3000
max. area	7,5 m ²
Open/Close max. (m/s) ¹⁾	1,5 / 0,5
max. Temperature range (extended on request) ²⁾	+10°C – +40°C

Material

Side frame	Aluminum anodized
Bottom profile	Flexible PVC
Top roll cover	Steel, powder coated
Motor cover	Steel, powder coated
Ramming protection	Steel, powder coated

Safety features

Door line photocell in the side frames	-
Light grid	✓
Crash system on the curtain / bottom profile ¹⁾	✓
Curtain monitoring	•
Suitable for use in escape routes	possible with building supervision
Automatic self opening in the event of a power failure	✓
Self opening	✓
Counterbalance	✓

Drive unit

Motor power	GfA 0,37 kW
Hand chain	-

Control system

DCC 20	✓ frequency converter
Fuse protection	16 A (K-Characteristics)
Potential free contacts	✓
Control voltage	24 V DC
Protection	IP 54
1L/(N) PE/220/230/380/400;50Hz	✓

PVC curtain to 0.9 mm thick

Vision panels	•
Wind taps	✓
Wind brace / wind ribs	•

Color code according to RAL color card	Door curtain + metalwork
Blue	✓ 5010
Red	• 3020
Graphite grey	• 7024
Stone grey	• 7030
Light grey	• 7035
White aluminium	• 9006
Pure white	• 9010
Anthracite grey	• 7016

• Option ✓ Standard – not possible

1) Deviations possible depending on other properties

2) depending on load alternation/minute, door size and installation location

General drawing ASSA ABLOY RR300 Retail

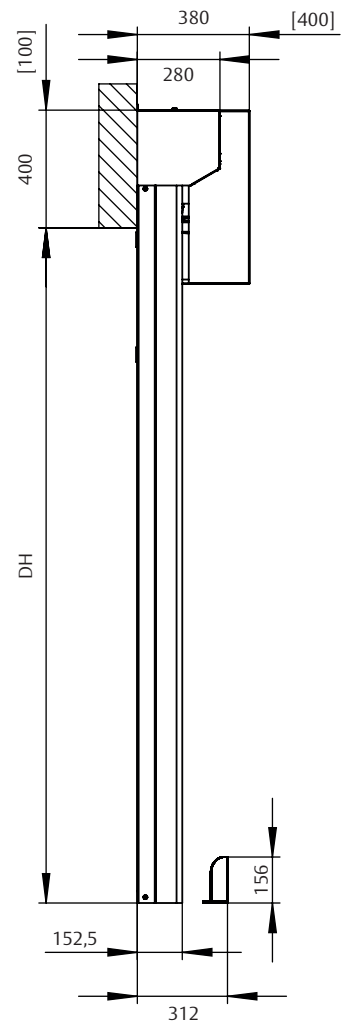
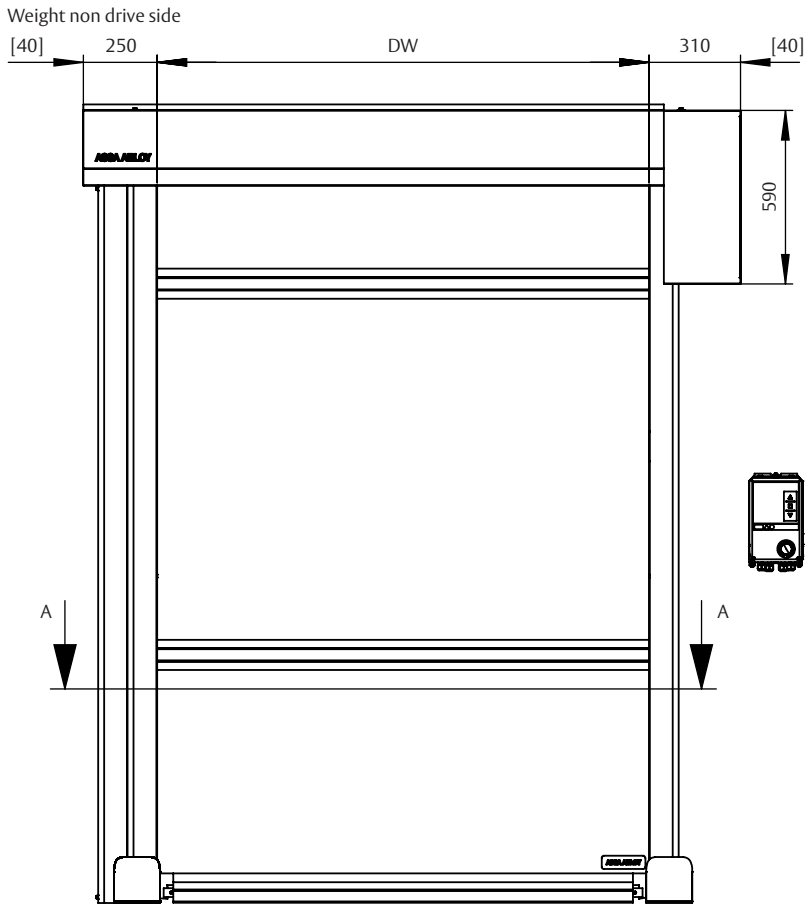

Section A-A
Weight non drive side

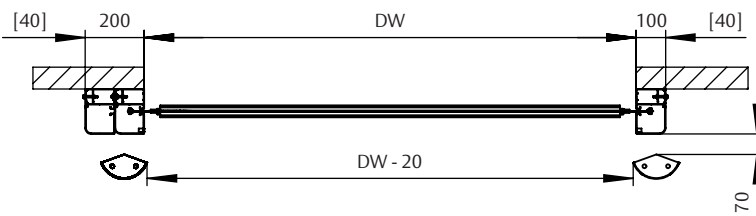

Section A-A
Weight drive side

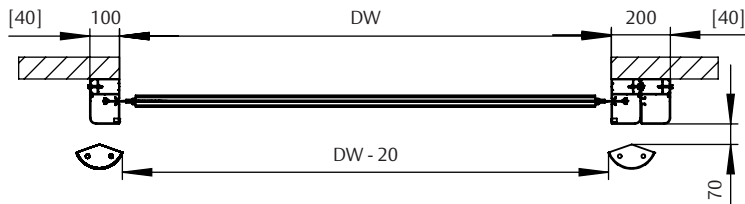

Weight drive side

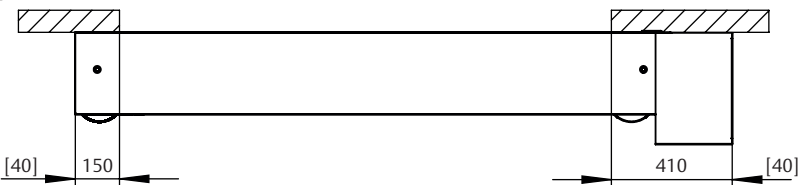

[] = Space needed for installation

Control system	
DCC 20	
Dimensions mm (W×H×D)	182×328×102

Available sizes		
	DW	DH
min.	750	1600
max.	2500	3000

The ASSA ABLOY Group is the global leader in access solutions. Every day, we help billions of people to experience a more open world.

ASSA ABLOY
Entrance Systems

ASSA ABLOY Entrance Systems provides solutions for efficient and safe flow of goods and people. Our offering includes a wide range of automated pedestrian, industrial and residential doors, loading dock equipment, perimeter fencing and service.



© ASSA ABLOY Entrance Systems AB PL/MAN/ASSA-ABLOY RR300 Retail/de_EN-1-1/2009 / 64 100 147 Technical data subject to change without notice

Follow us:



Please enter ASSA ABLOY Entrance in the channel's search field.